

LUX ELEMENTS®  
www.luxelements.com



## LUX ELEMENTS®-RELAX-RD

Montageanleitung  
Instructions for assembly  
Instruction de montage  
Montagehandleiding

LUX ELEMENTS  
GmbH & Co. KG  
P-AB/20802/05-2008

Herstellung einer Abdichtung im Verbund mit Fliesen- und Plattenbelägen unter Einsatz von LUX ELEMENTS®-TUB als Abdichtungssystem gemäß Bauregelliste A Teil 2, lfd. Nr. 1.10, Beanspruchungsklasse A2

## LUX ELEMENTS®-RELAX-RD

01 | 2012

**D Bitte beachten Sie** – ... unsere Datenblätter, die weitere technische Informationen zur Montage und Verlegung von Belagsmaterialien enthalten. Sie können diese kostenlos von unserer Homepage herunterladen. Generell empfehlen wir bei einer Verlegung von Mosaik von < 5 x 5 cm eine Verklebung und Verfugung mit Reaktionsharz.

**GB Please observe** – ... our data sheets. These contain further technical information regarding the installation and laying of covering materials. You may download them free of charge from our homepage. We generally advise for tiles < 5 x 5 cm to use epoxy for gluing and grouting.

**F Veuillez tenir compte** – ... de nos fiches techniques qui contiennent de plus amples informations techniques sur le montage et la pose des matériaux de revêtement. Vous pouvez les télécharger gratuitement sur notre site internet. Pour la mise en oeuvre de mosaïque d'un format < 5 x 5 cm nous conseillons un collage et un jointoyement à l'époxyle.

**NL Let op** – ... onze gegevensbladen te letten. Deze bevatten verdere technische informatie m.b.t. plaatsing van afdekmaterialen. U kan deze kosteloos van onze internetpagina downloaden. Algemeen adviseren wij bij het kleven en het voegen van mosaik < 5 x 5 cm een epoxylijm te gebruiken.

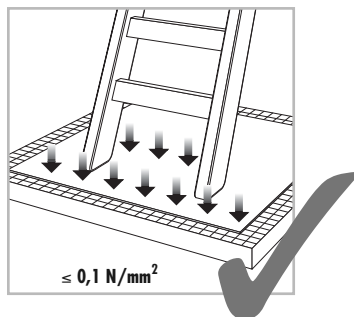
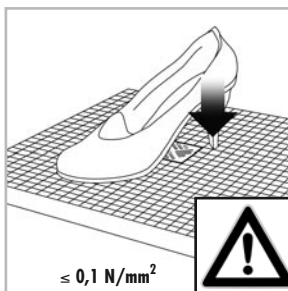

**D BITTE BEACHTEN SIE ...**

... **Ablauftopf vor Montage nicht durch Einrasten an den Duschboden befestigen!**

**GB PLEASE OBSERVE ...**

... **do not engage the drain pan to the shower base prior to installation!**

**F VEUILLEZ TENIR COMPTE ...**

... **ne pas fixer le siphon de sol au receveur de douche avant le montage!**

**NL LET OP ...**

... **afvoer niet voor montage vastklikken aan het douchebakelement!**

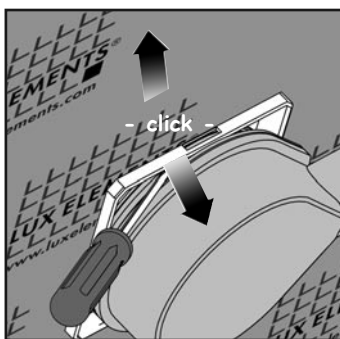

**D** – Falls notwendig, lässt sich der Ablauftopf mit Hilfe eines Hebels (z.B. Schraubendreher) wieder vom Aufnahmerahmen trennen.

**GB** – If necessary, the drain pan may be removed from the attachment frame with the aid of a lever (i.e. screwdriver).

**F** – Si nécessaire, le siphon de sol peut être séparé au moyen d'un levier (p.ex. tournevis), du cadre de réception.

**NL** – Indien nodig, is de afvoerpot met behulp van een hefwerktuig (b.v. schroevendraaier) weer scheidbaar van het ingebouwde montageaam.

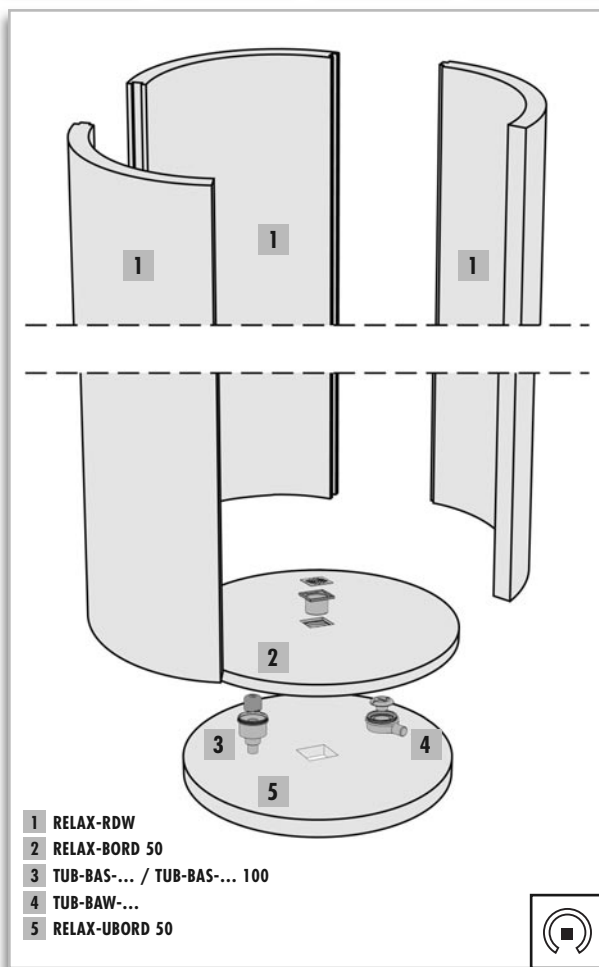
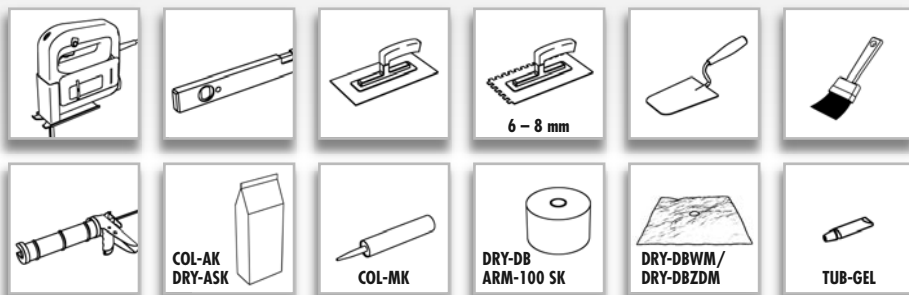

# LUX ELEMENTS®-RELAX-RD

01 | 2012

# 1.1

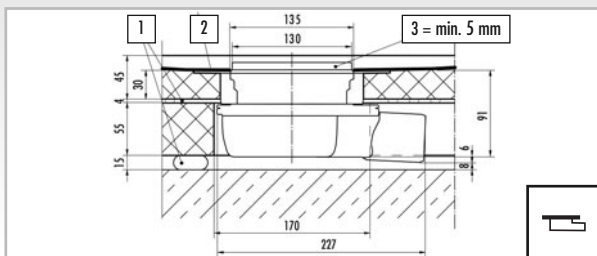

**D**

- 1 Kleberschicht
- 2 Abdichtung
- 3 Höhenanpassung

**F**

- 1 Couche de colle
- 2 Étanchéité
- 3 Adaptation en hauteur

**GB**

- 1 Adhesive layer
- 2 Seal
- 3 Height adjustment

**NL**

- 1 Lijm laag
- 2 Afdichting
- 3 Hoogteaanpassing

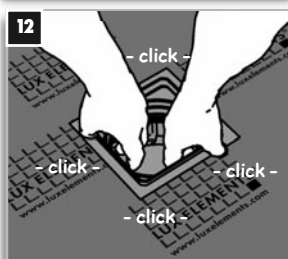
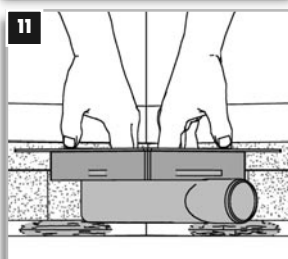
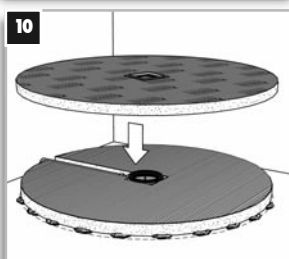
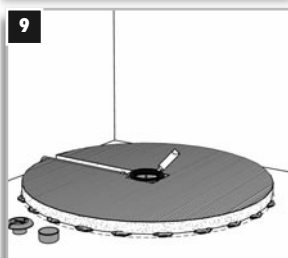
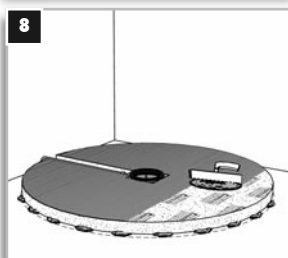
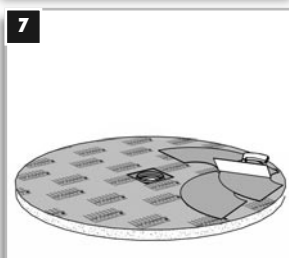
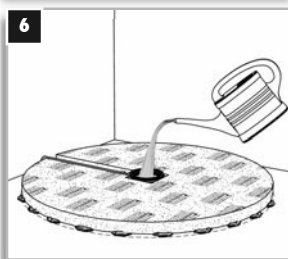
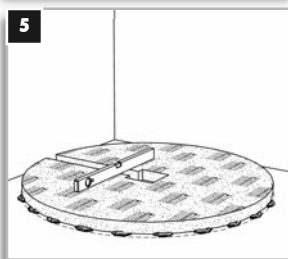
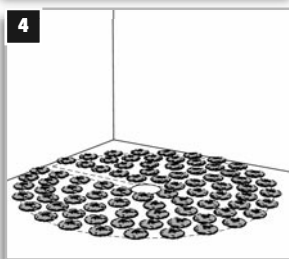
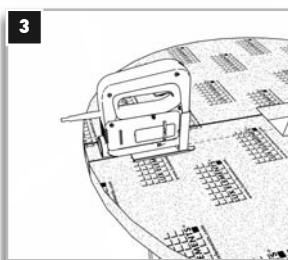
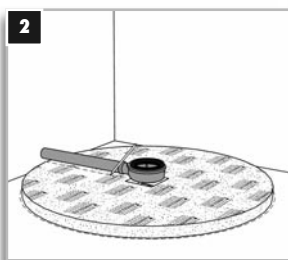
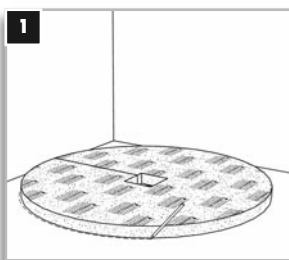

# LUX ELEMENTS®-RELAX-RD

01 | 2012

# 1.2

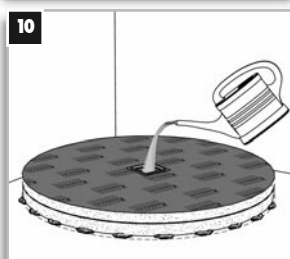
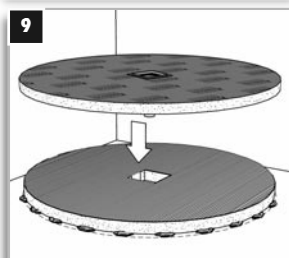
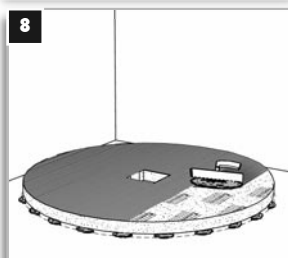
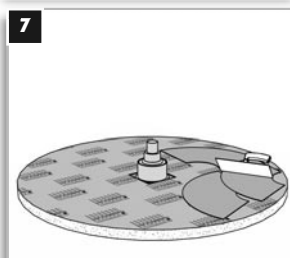
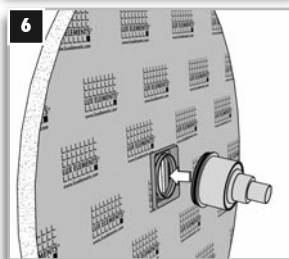
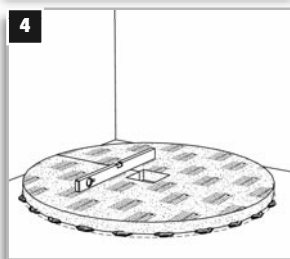
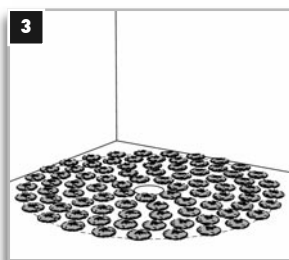
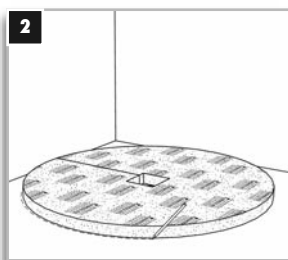
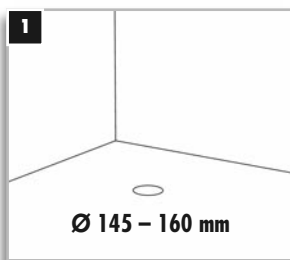
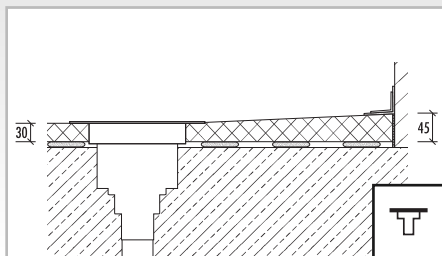
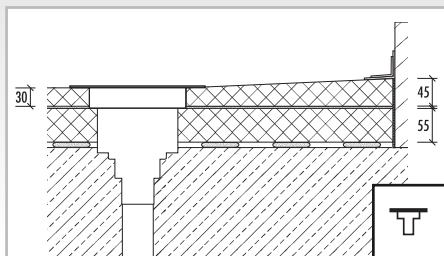

▶ 9  
**1**

# LUX ELEMENTS®-RELAX-RD

01 | 2012

# 1.3

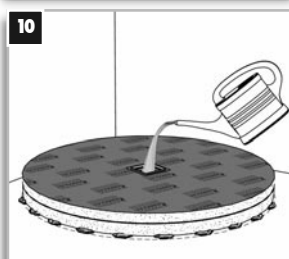
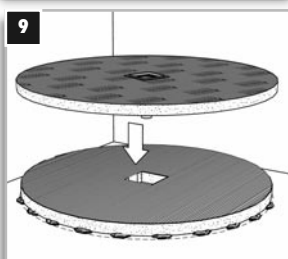
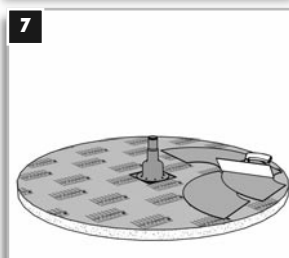
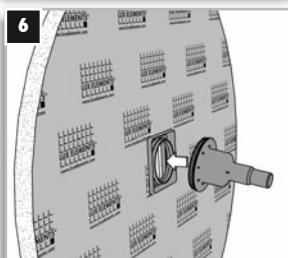
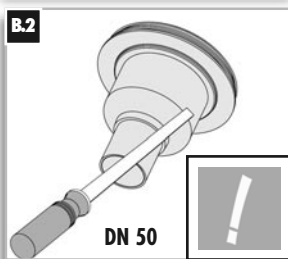
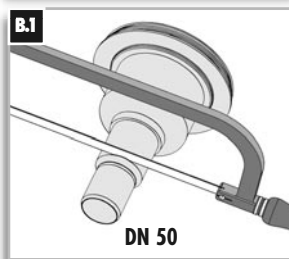
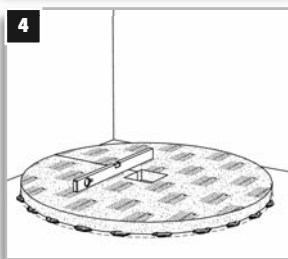
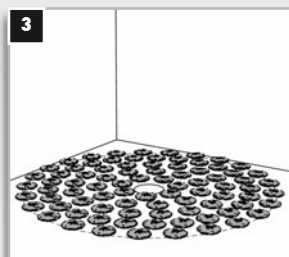
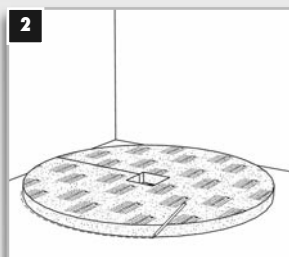
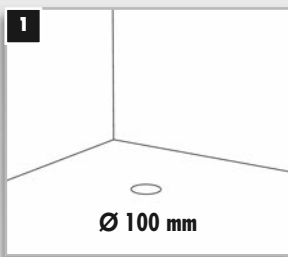

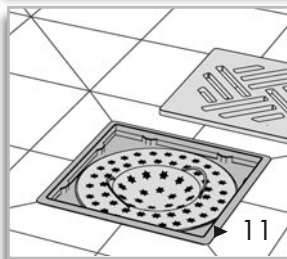
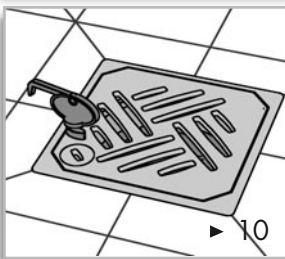
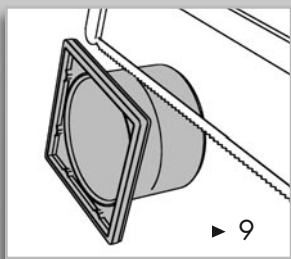
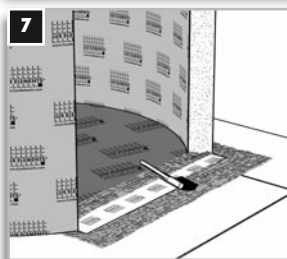
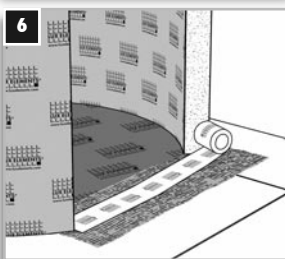
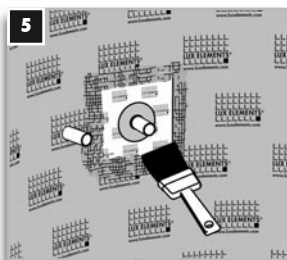
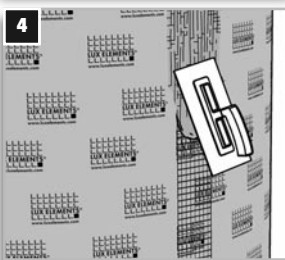
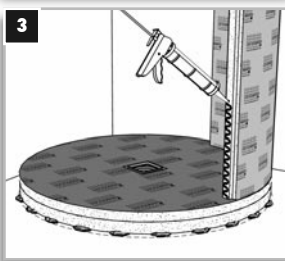
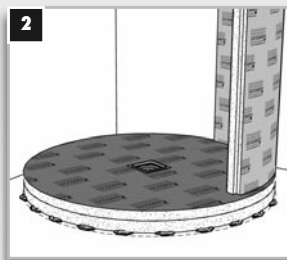
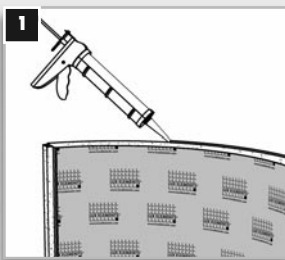

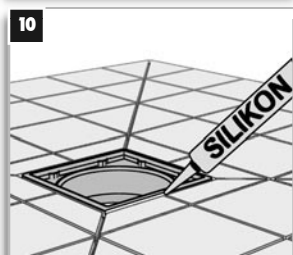
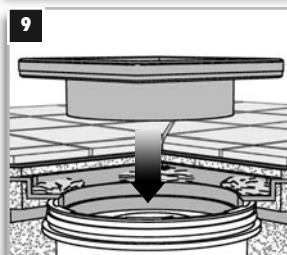
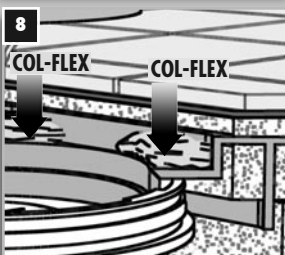
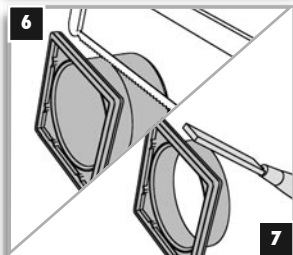
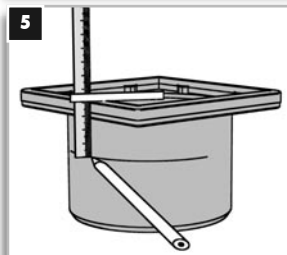
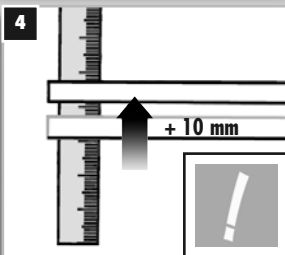
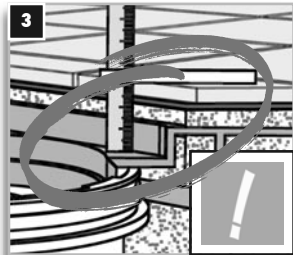
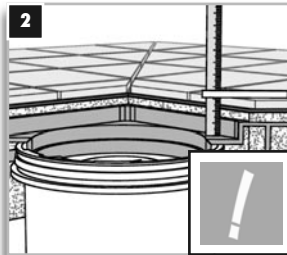
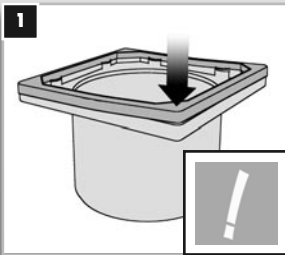
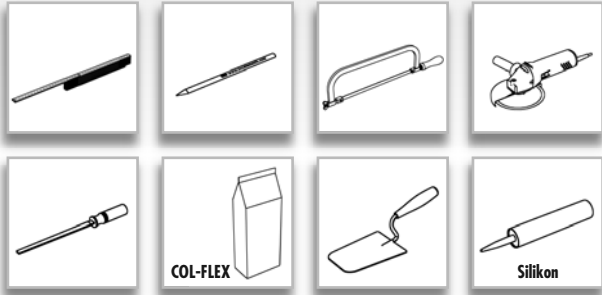



Rost / grate / grille / ster	Belagsstärke / Upper layer thickness / Épaisseur de la couche supérieure / Dikte van de bekleding (Fliesen + Kleber) (tile + adhesive) (carreau + colle) (tegel + lijm)		
LUX ELEMENTS®-TUB-BA... -S	Duschboden/shower base/receveur de douche/douchebak	min./at least/au moins/minstens	5 mm
LUX ELEMENTS®-TUB-BA... -DS	Duschboden/shower base/receveur de douche/douchebak	min./at least/au moins/minstens	5 mm
LUX ELEMENTS®-TUB-BA... -DA, -DC, -DL, -DM	Duschboden/shower base/receveur de douche/douchebak	min./at least/au moins/minstens	5 mm
LUX ELEMENTS®-TUB-BA... -DV	Duschboden/shower base/receveur de douche/douchebak Befliesbare Abdeckung/tileable cover/cadre de réception à carreler/bekleding	min./at least/au moins/minstens	5 mm 8 mm
LUX ELEMENTS®-TUB-BA... -DF	Duschboden/shower base/receveur de douche/douchebak Befliesbare Abdeckung/tileable cover/cadre de réception à carreler/bekleding	min./at least/au moins/minstens	14 mm 11 mm

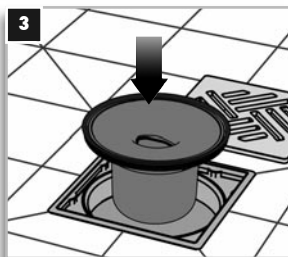
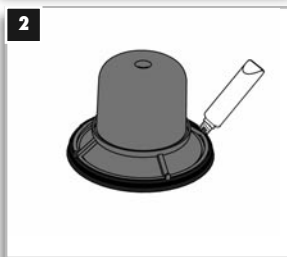
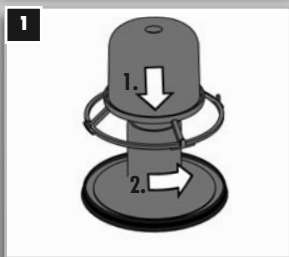
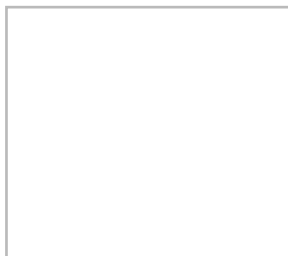
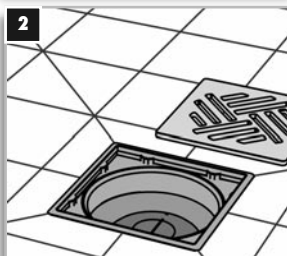
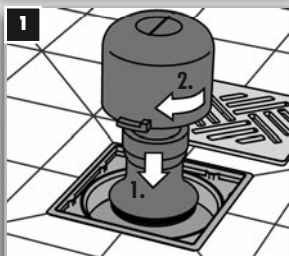
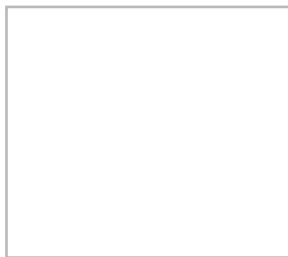
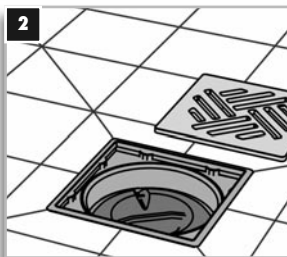
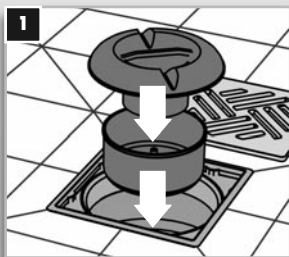

# LUX ELEMENTS®-RELAX-RD

01 | 2012

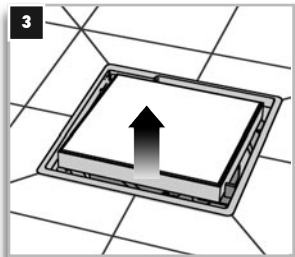
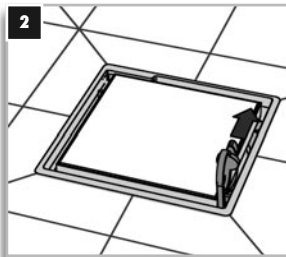
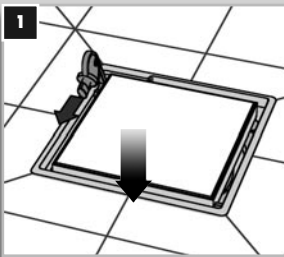
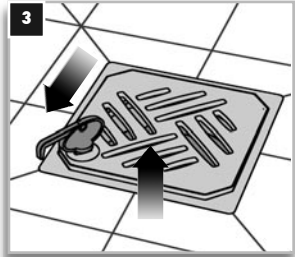
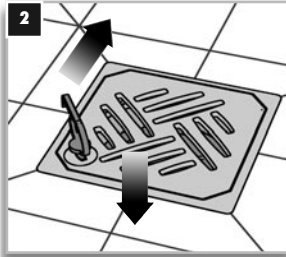
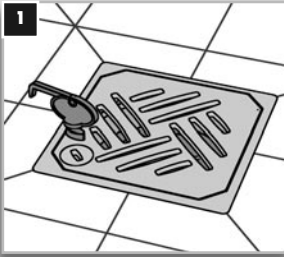
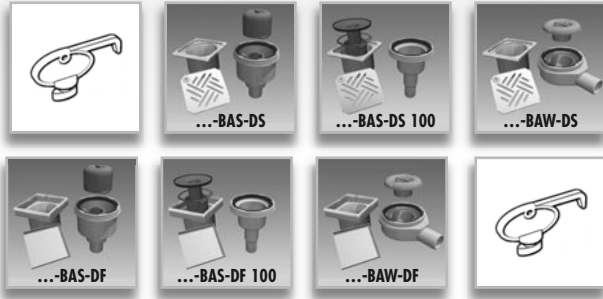

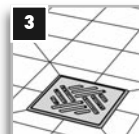
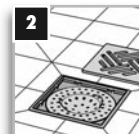
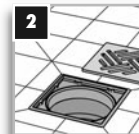
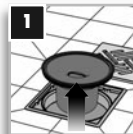
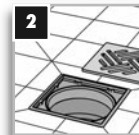
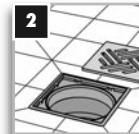
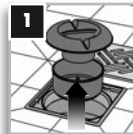
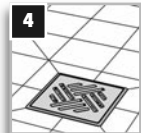
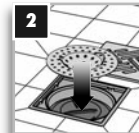
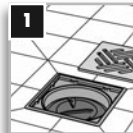
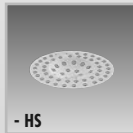
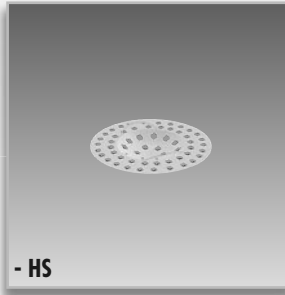



**D Bitte beachten Sie ...**

- bei bodengleichen Duschtassen, dass es bei
- geringer Gefälleausbildung
  - grober Keramik
  - fehlender Duschtrennung
  - ungünstiger Duschkopfanzordnung
  - hohem Wasserdruck bzw. hoher Wassermenge (z. B. bei Schwallbrausen)

Wasser aus dem Duschbereich austreten bzw. es zu einem Wasserrückstau kommen kann. Bitte beachten Sie unsere Planungshilfen und FAQs zur Duschbodenplanung im Internet auf unserer Homepage.



**GB Please observe ...**

- that with flush with the floor shower bases, in the case of
- a low slope
  - rough ceramics
  - the lack of a shower enclosure
  - unfavourable shower head placement
  - high water pressure or high quantity of water (e.g. in the case of flood showers)

water can run out of the shower area or accumulate. Please refer to our planning aids and FAQ's on shower base planning on our website.



**F Veuillez tenir compte ...**

- que les receveurs de douche à fleur de sol peuvent dans les cas suivants avec :
- une faible pente
  - une céramique à surface très irrégulière
  - une absence de cloison de douche
  - un placement défavorable de la pomme de douche
  - une pression ou une quantité d'eau élevée (p.ex. en cas de douche torrent ou ciel de pluie)

présenter un risque de débordement et engendrer des reflux d'eau. Consultez nos fiches de montage et nos FAQ sur la mise en œuvre des receveurs de douche à fleur de sol sur notre page d'accueil.



**NL Let op ...**

- bij met de vloer gelijkgewerkte douchebakken maken we u er op attent dat er bij
- geringe helling
  - grove keramiek
  - niet voorhanden douche afscheiding
  - ongunstige plaatsing van de douchekop
  - hoge waterdruk resp. grote hoeveelheden water (bv. stortdouchen)

water uit het doucheberek kan komen resp. dat het tot wateropstuwing kan komen. Bekijk a.u.b. onze hulp voor de planning en de FAQ's voor de douchevloer planning in het internet op onze homepage.



**D**

LUX ELEMENTS GmbH & Co. KG  
 An der Schusterinsel 7  
 D - 51379 Leverkusen-Opladen

Tel. +49 (0) 21 71/72 12-0  
 Fax +49 (0) 21 71/72 12-40

E-Mail [info@luxelements.de](mailto:info@luxelements.de)  
 Web [www.luxelements.com](http://www.luxelements.com)

**F**

LUX ELEMENTS S.A.S  
 31, rue d'Ensisheim  
 F - 68190 Ungersheim

Tél. +33 (0) 3 89 83 69 79  
 Fax +33 (0) 3 89 48 83 27

E-Mail [info@luxelements.fr](mailto:info@luxelements.fr)  
 Web [www.luxelements.fr](http://www.luxelements.fr)